



Device-to-Device for Public Safety (DDPS)

*4th OpenAirInterface Workshop
November 7th and 8th, 2017
Orange Gardens, Paris France*

*Contact: Jérôme Härri
Email: haerri@eurecom.fr*

*NIST DDPS contact: Richard Lau
Email: clau@vencorelabs.com*

This work was performed under the following financial assistance award 70NANB17H167 from U.S. Department of Commerce, National Institute of Standards and Technology.

Acknowledgements

- DDPS is a National Institute of Standards and Technology (NIST) Public Safety Innovation Accelerator Program (PSIAP)
- Vencore Labs (Prime) and EURECOM collaborate on DDPS technology
- Vencore Labs
 - Richard Lau (NIST DDPS PI)
 - Tony Triolo (NIST DDPS co-PI)
 - Stephanie Demers
 - William Johnson
 - Heechang Kim
 - James Dixon
- EURECOM
 - Raymond Knopp
 - Panagiotis Matzakos
 - Tien-Thin Nguyen
 - Cedric ROUX



OpenAirInterface
5G software alliance for democratising wireless innovation

<http://www.openairinterface.org/>

Problem Space & Stakeholders

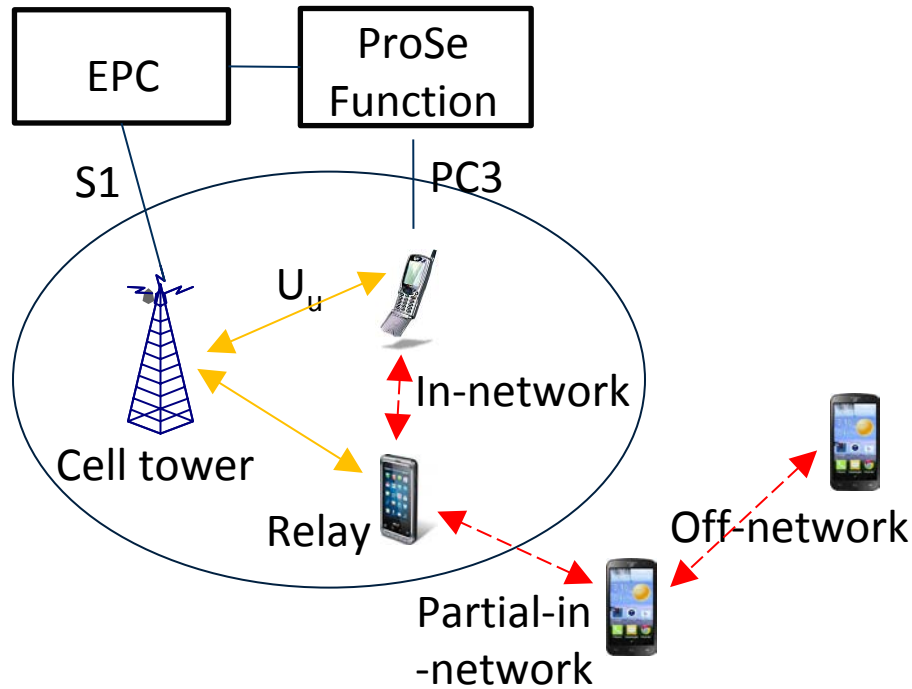

◄---◄---► New sidelink channel
◄---► Existing LTE channel

Key Stakeholders:

- Law enforcement
- Firefighters
- Medical personnel
- Military organizations
- Volunteer groups

Key CONOPS for Public Safety:

- Fall back in the event of complete LTE network failure, e.g. natural disasters
- UE-UE communication within coverage
- UE-UE communication outside coverage
- Mixture of UE communication within and outside coverage

Key Services:

- ✓ Mission-Critical Voice
- ✓ 3GPP Proximity Service (ProSe)
- ✓ 1:1 and 1:many Group Communication
- ✓ Service Continuity

DDPS Objectives

- Build complete ProSe stack by extending current OpenAirInterface™ implementation to include ProSe services based on 3GPP Rel-14 specifications
- Solve open issues related to resource allocation, time synchronization, and service continuity
 - Develop new scheduling algorithms for autonomous resource allocation to minimize collision probability.
 - Develop novel multi-antenna-based synchronization techniques to achieve significant improvement in UE autonomous synchronization
 - Solve complex service continuity challenges for on-, off-, and partial-on-network operations
- Demonstrate ProSe solution on software defined radio platform
- Help create an ecosystem that can be provided to interested vendors for commercialization on a system-on-a-chip platform

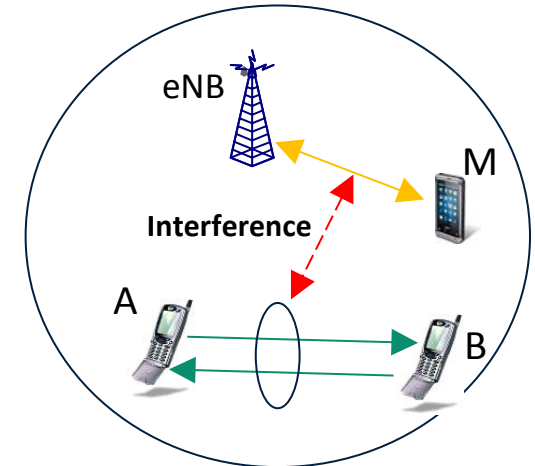

Interference

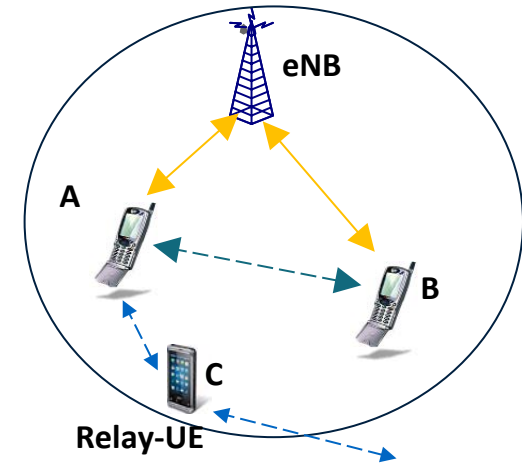

Service Continuity

DDPS Scenarios

- **Scenario 1: Off-Network D2D**

- Two UEs are off-network but communicate directly via a sidelink channel

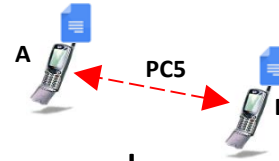

- **Scenario 2: On-Network D2D**

- Two UEs are located close to their eNodeB but communicate directly via a sidelink channel

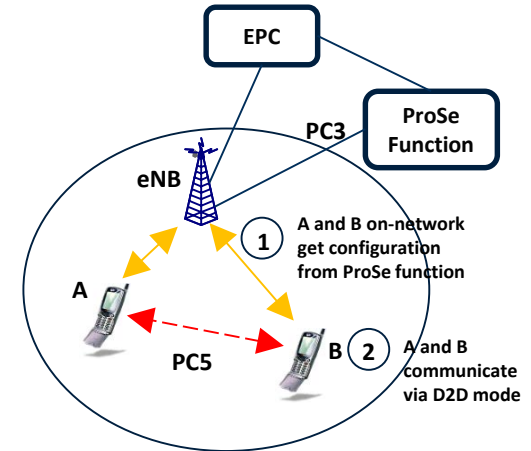

- **Scenario 3: UE-to-Network Relay**

- UE A is close to its eNodeB while a second UE B is out-of-coverage but within coverage of UE A. UE A acts as a relay to remote UE B and relay its traffic (e.g., to a FTP server, or another on-network UE C)

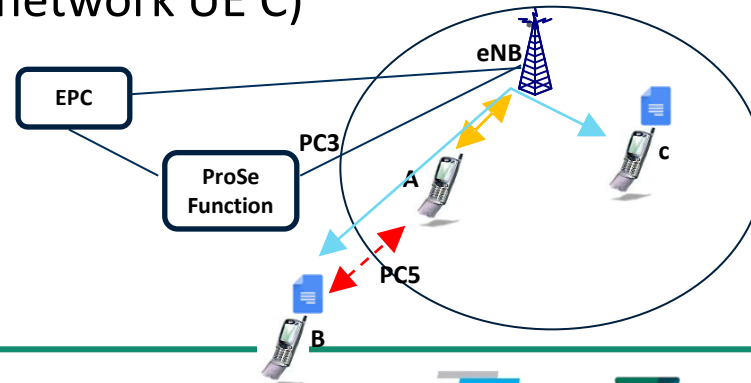

LTE ProSe 3GPP Standardization Timeline

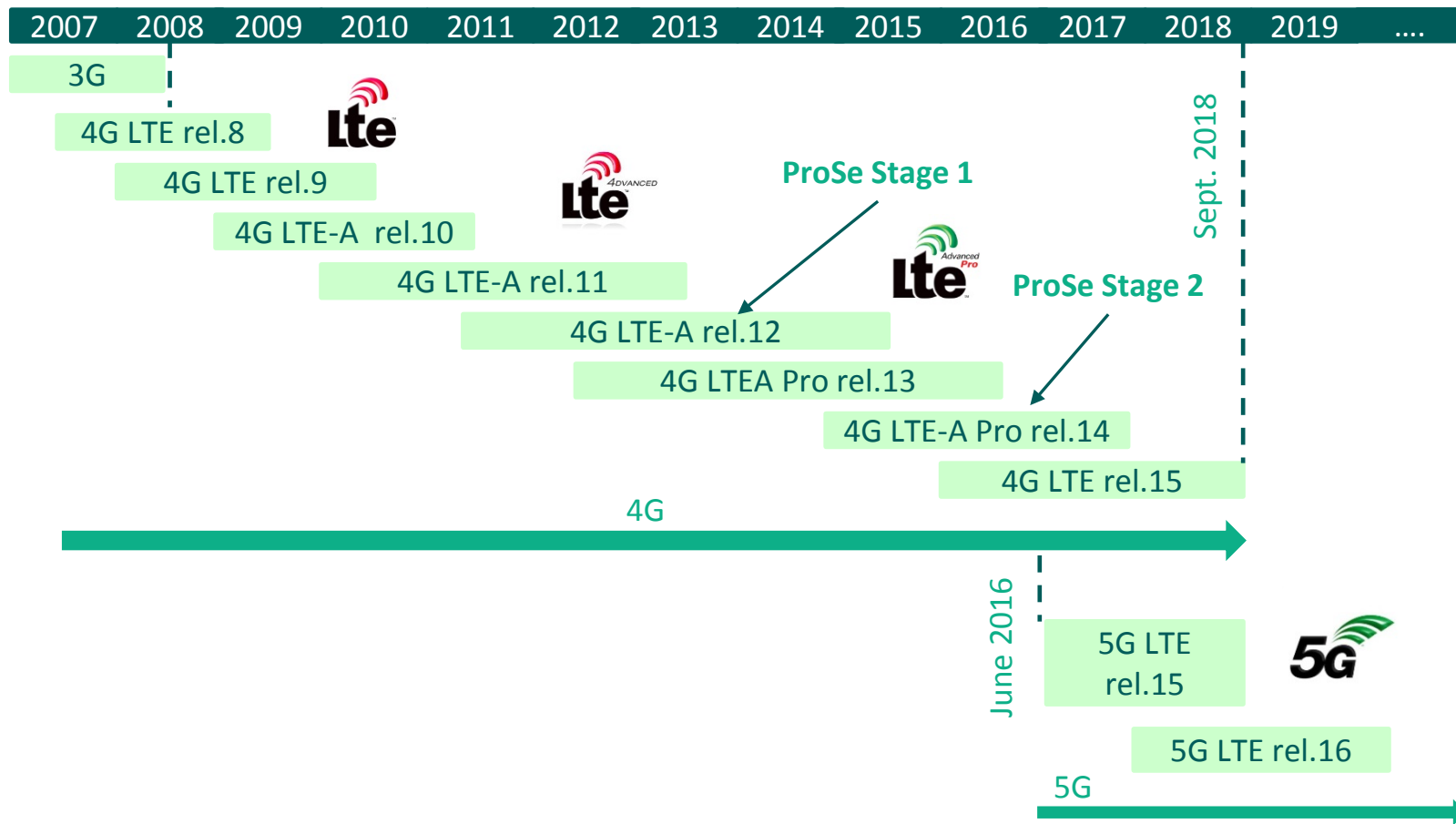

ProSe: Proximity Services

LTE Proximity Services (ProSe)

- LTE ProSe enables establishment of communication paths between two or more ProSe-enabled UEs.
- LTE ProSe enables communication functions
 1. One-to-One – Direct UE-to-UE Communication
 2. One-to-Many - Communication to a ProSe group
- LTE ProSe Functions:
 - Discovery
 - Mode A – ‘I am here’
 - Mode B – ‘how is there ?’
 - Direct Communication
 - Mode 1 – Coordinated by eNB
 - Mode 2 – Ad-Hoc mode

Restricted to Public Safety (rel.14)



LTE Prose Extended Architecture

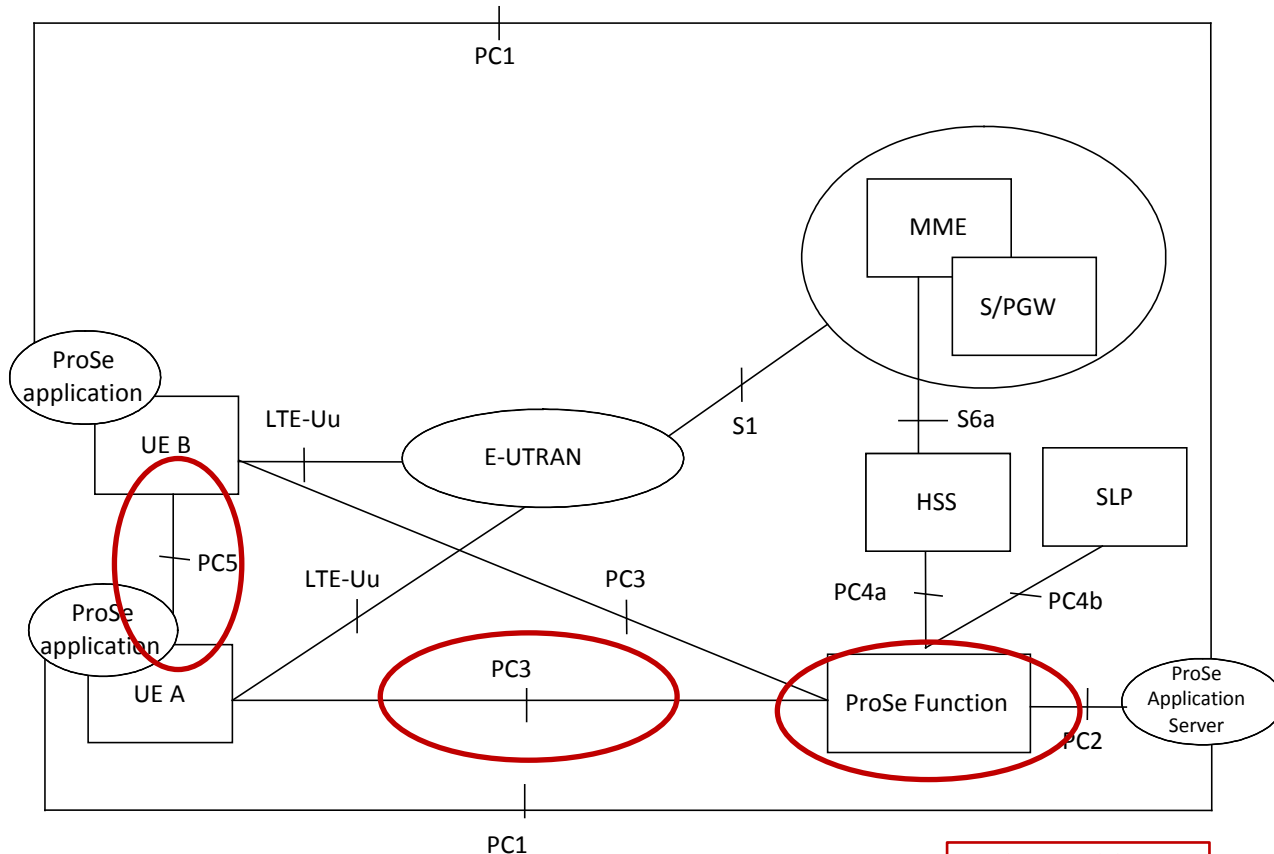

New Architecture Elements:

- a) **ProSe Function** – management of D2D communication (authentication, discovery)
- b) **PC5 interface** – UE to UE
- c) **PC3 interface** – Prose Function to UE

LTE ProSe – New Sidelink (SL) Channels

a) Sidelink Channels

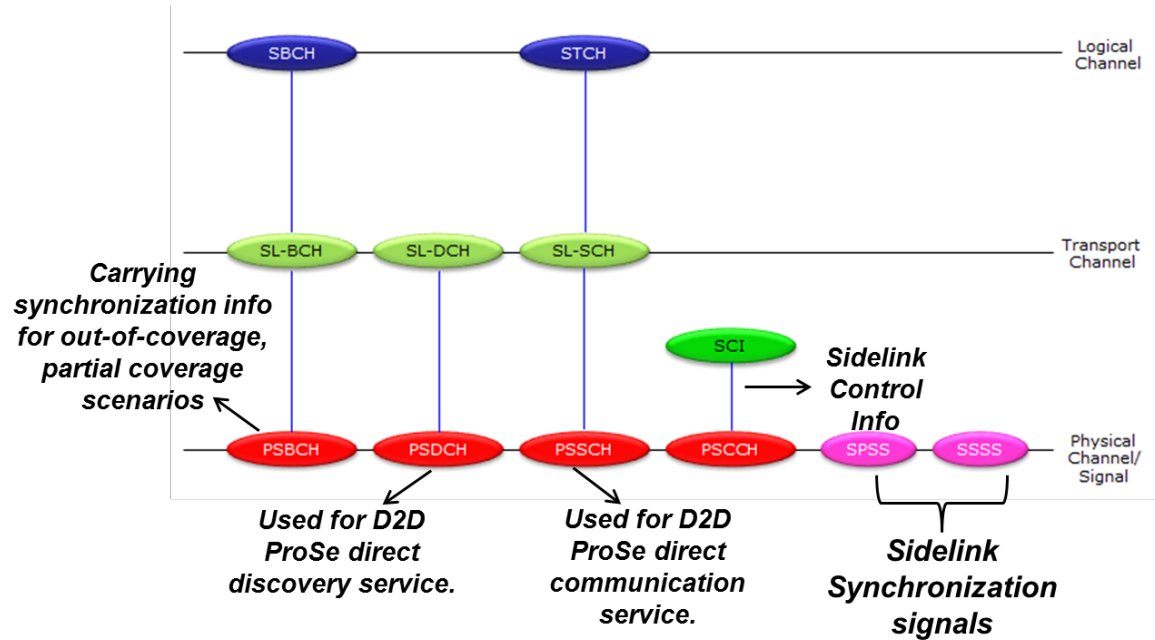

b) Sidelink Pool

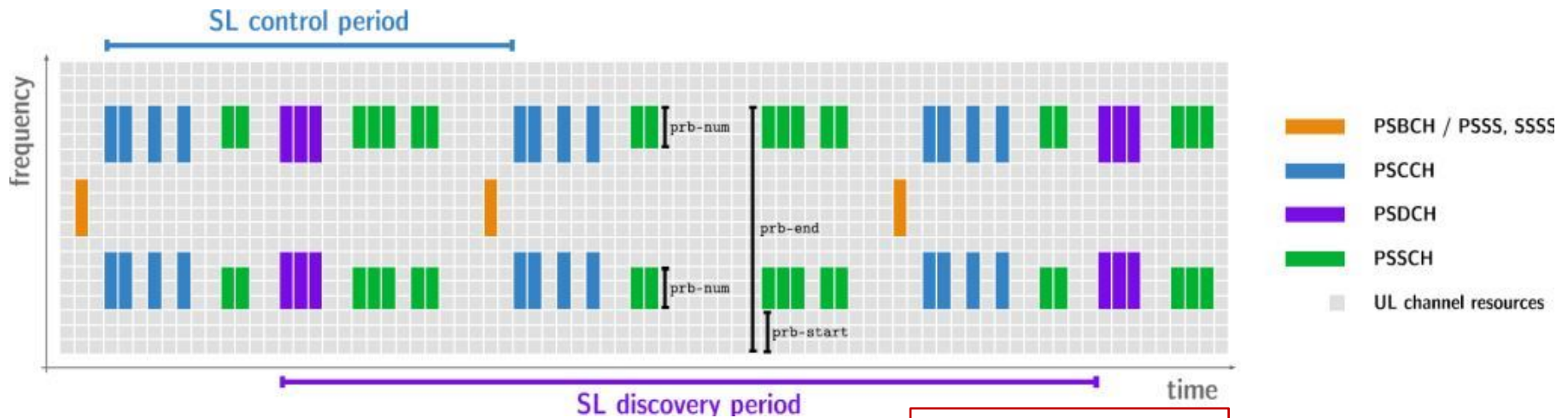

Source: Dr. Gallo, EURECOM

Discovery & One-to-One Communication

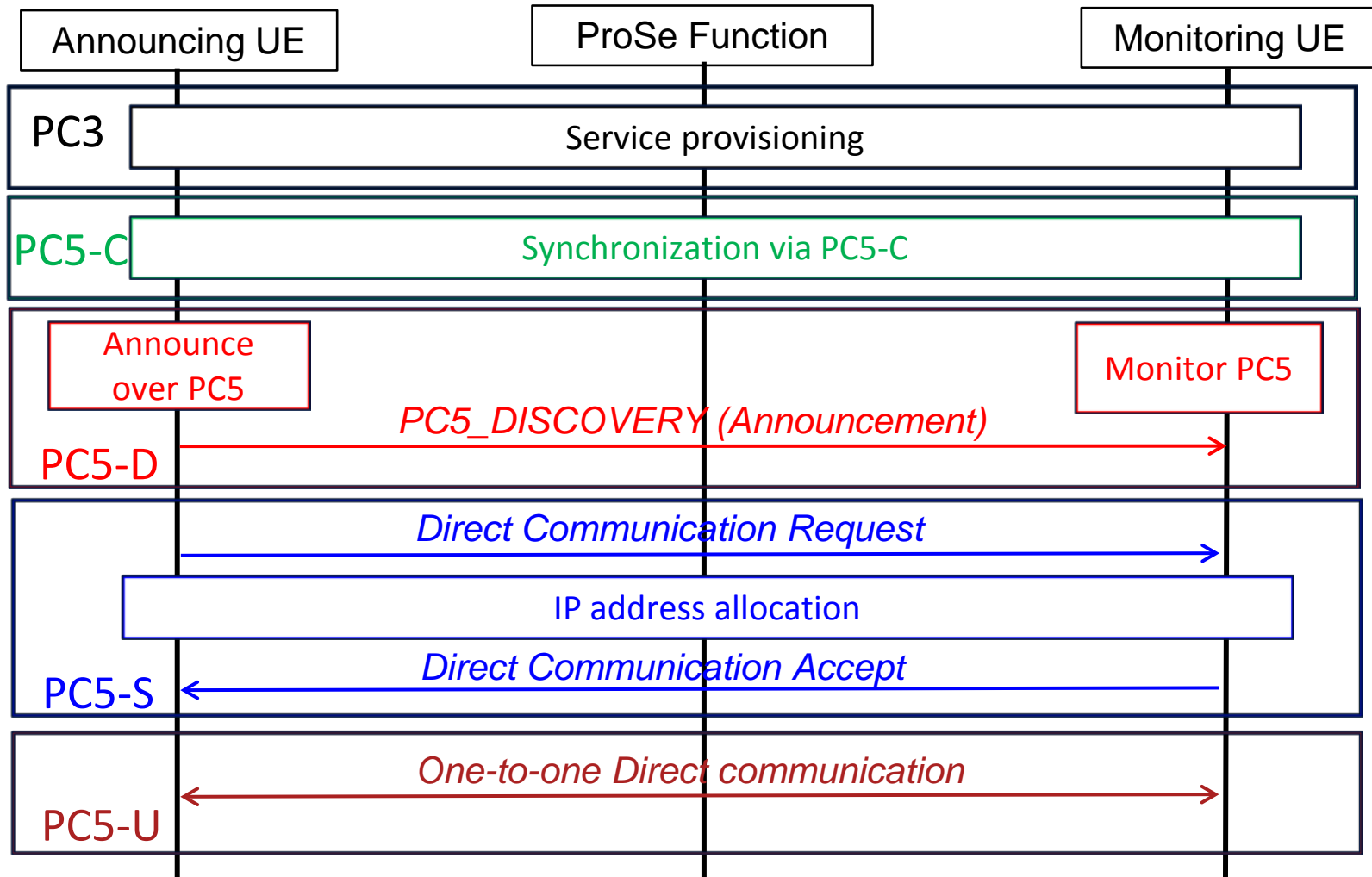

Relay Discovery, Selection & Direct Communication

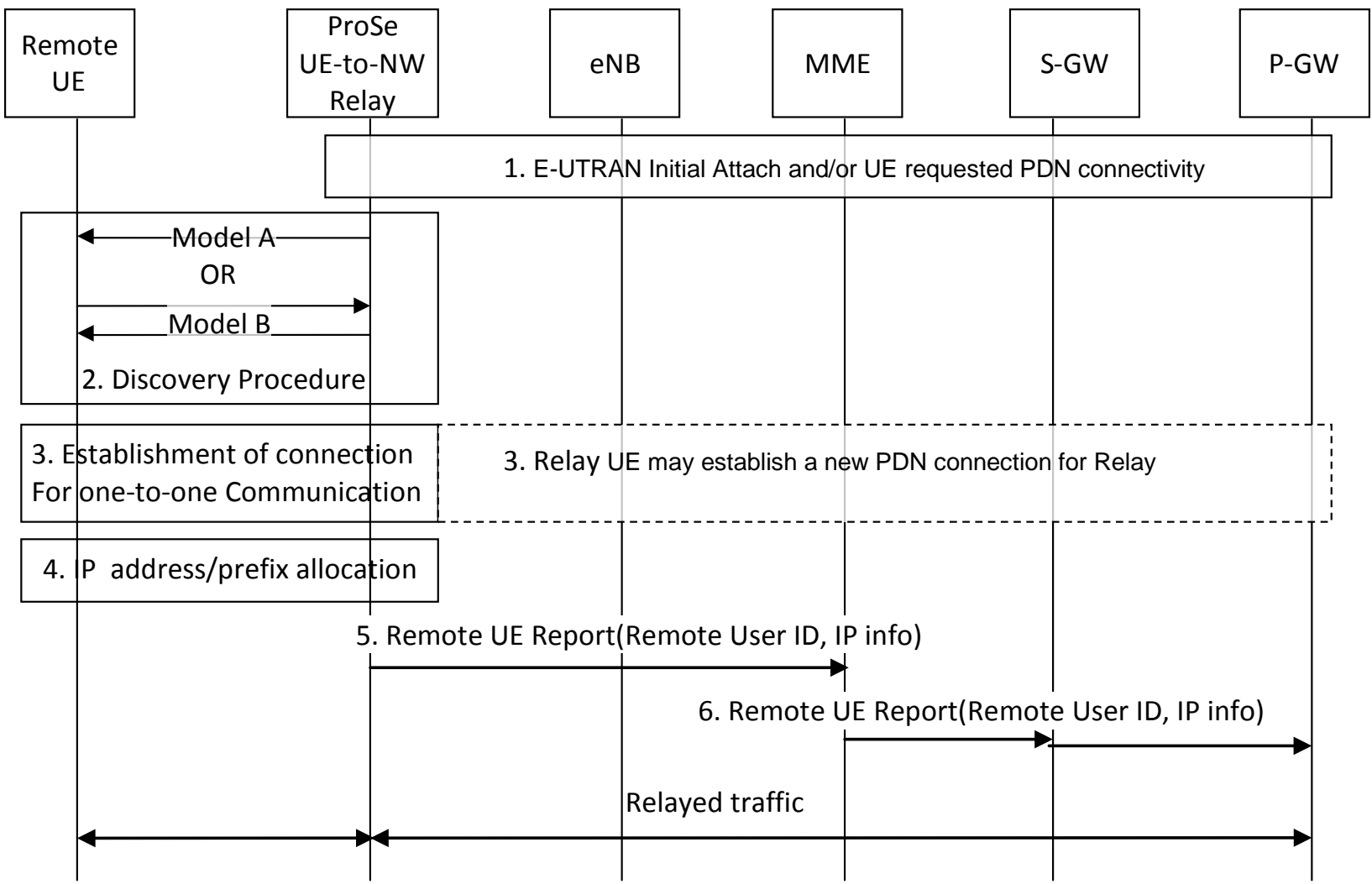

OAI Architecture for ProSe Interfaces

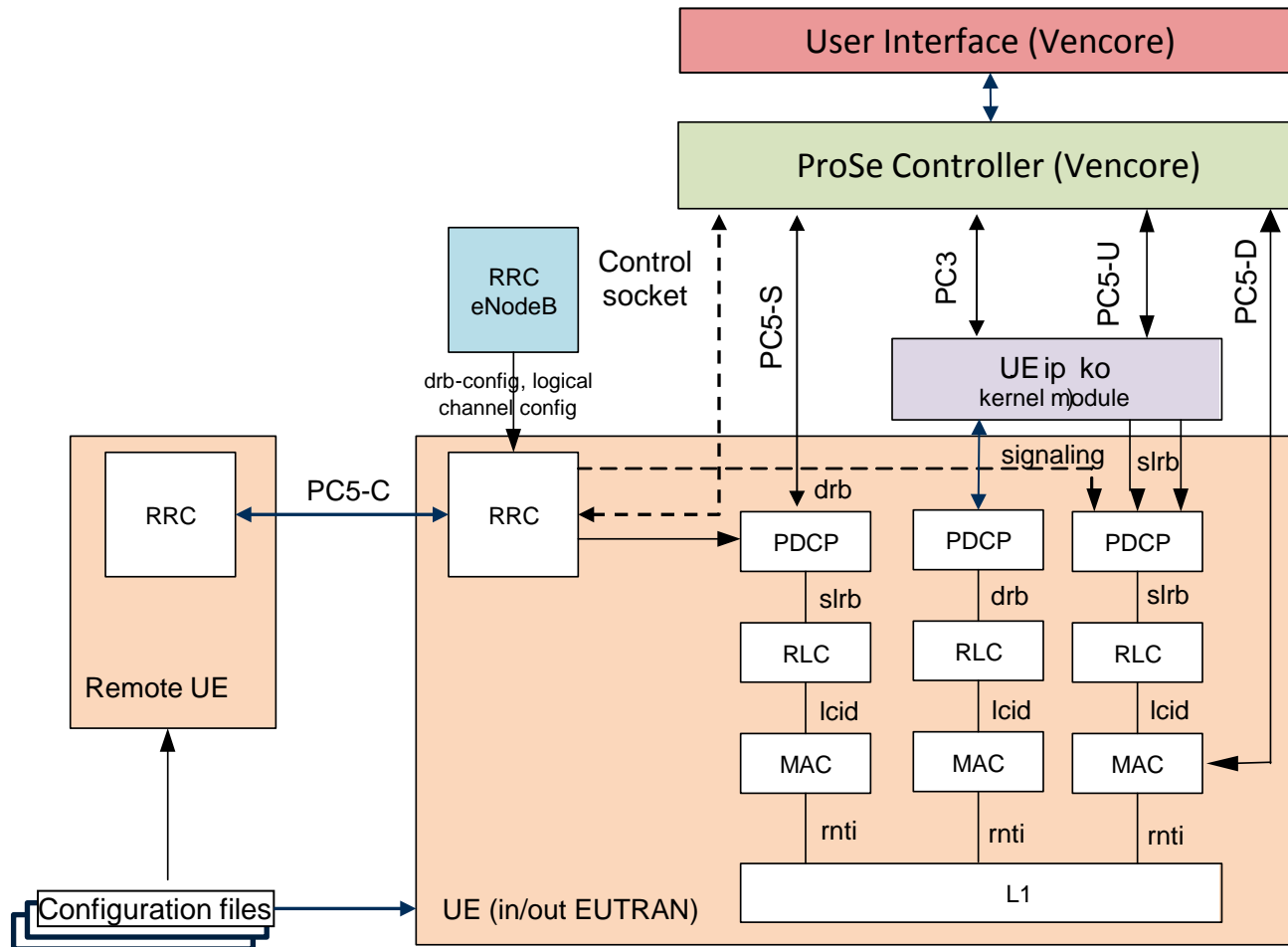

OAI Emulation Extensions for DDPS

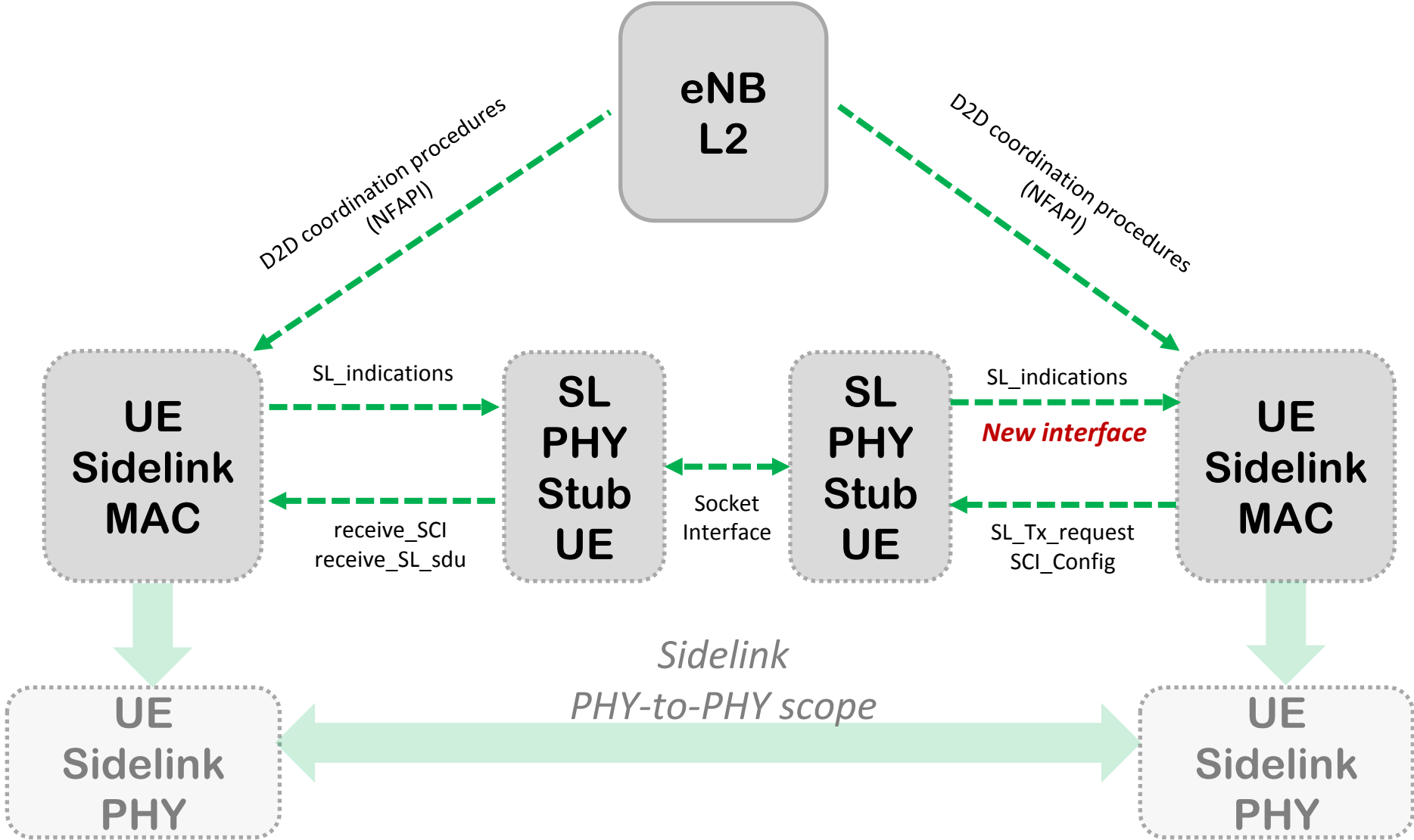

D2D for Public Safety on OAI – RoadMap

- **Phase 1 Stage 1 - Emulation**
 - Redesign of emulation mode – new PHY STUB
- **Phase 1 Stage 2 - Implementation**
 - Part A – Implementation of the ProSe Function/RRC/PDCP/RLC/MAC
 - Part B – Implementation of the PHY
- **Phase 1 Stage 3: Performance Evaluation**
 - Emulation-based Proof-of-Concept and Performance Evaluation

- **Phase 2 – Real-Time Lab**
 - Real-time UE PHY and Field Deployment

← Not Yet Approved...

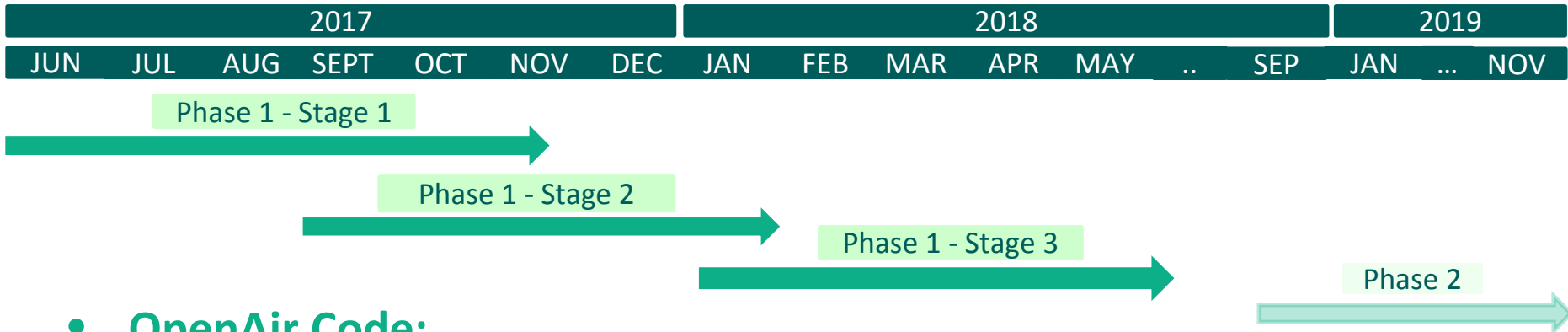

- **OpenAir Code:**

- <https://gitlab.eurecom.fr/matzakos/LTE-D2D>



Device-to-Device for Public Safety (DDPS)

*4th OpenAirInterface Workshop
November 7th and 8th, 2017
Orange Gardens, Paris France*

*Contact: Jérôme Härri
Email: haerri@eurecom.fr*

*NIST DDPS contact: Richard Lau
Email: clau@vencorelabs.com*

This work was performed under the following financial assistance award 70NANB17H167 from U.S. Department of Commerce, National Institute of Standards and Technology.